

## PENTE DE LA TOITURE

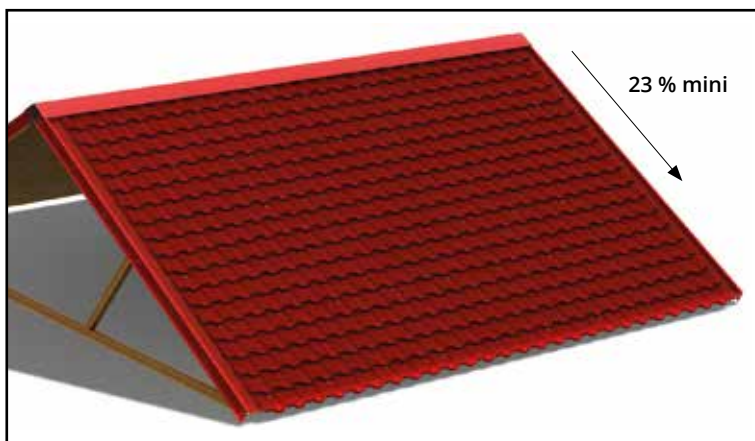

Calculer facilement la pente

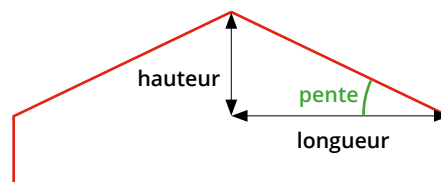

$$\text{Pente (\%)} = \frac{\text{hauteur}}{\text{longueur}} \times 100$$

TABLEAU DE CONVERSION - PENTE

Degrés	13°	14°	15°	16°	18°	20°	22°	24°	26°	28°	30°	32°	34°	36°	38°	40°
Pourcent	23%	25%	28%	29%	32%	36%	40%	44%	49%	53%	58%	62%	67%	73%	78%	84%

## DOMAINE D'EMPLOI

La Tuile R PRO® est le produit idéal pour votre toiture . Elle convient aussi bien aux constructions neuves qu'à la rénovation de toiture.

### EN CONSTRUCTION NEUVE

SUPPORT CONTINU



SUR LITEAU



### EN RÉNOVATION

#### SUR BARDEAU BITUMÉ OU SUR COUVERTURE ONDULÉE

SUPPORT CONTINU



SUR LITEAU

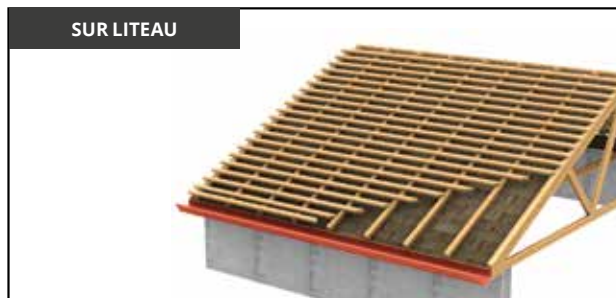

Avant la rénovation, il est nécessaire de s'assurer du bon état de la charpente et de la structure porteuse.

Si la toiture est étanche la pose de la Tuile R PRO® peut s'effectuer directement, si ce n'est pas le cas, il est nécessaire de prévoir la pose d'un pare pluie (se référer à l'avis technique du pare pluie utilisé).

## POSE SUR LITEAUX

Pour une pose sur liteaux, 1 liteau doit être prévu au droit de chaque pureau.

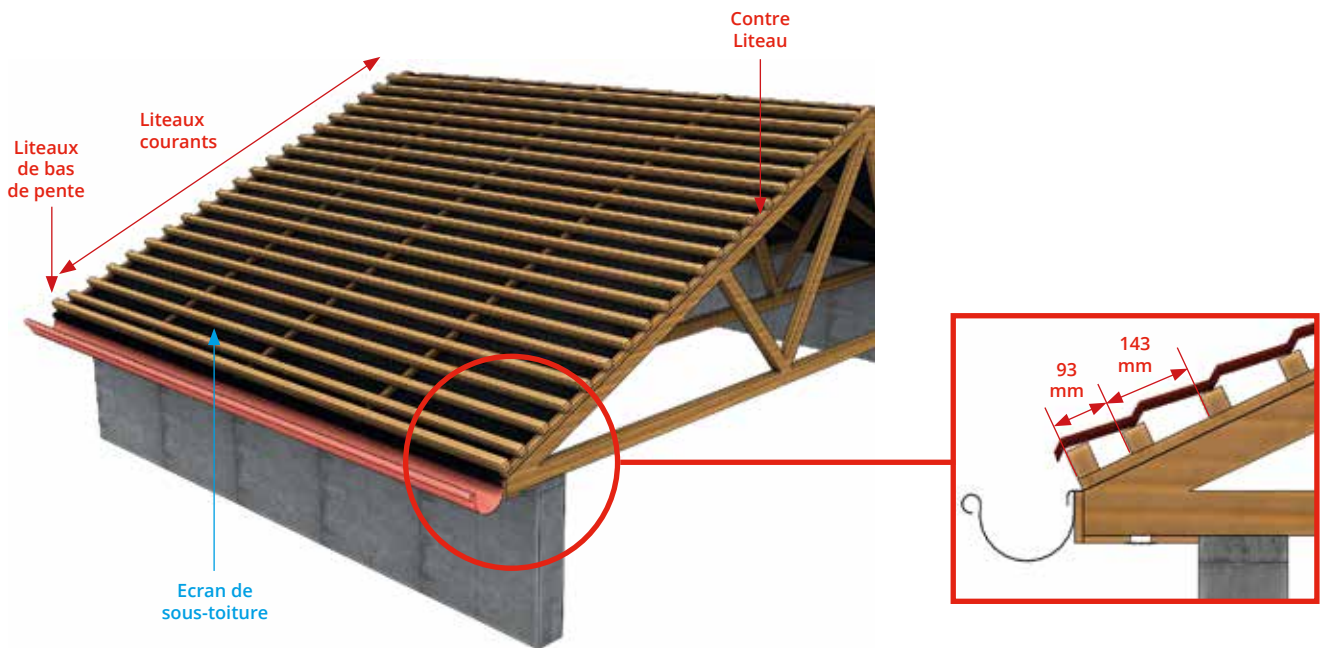

## RÉNOVATION

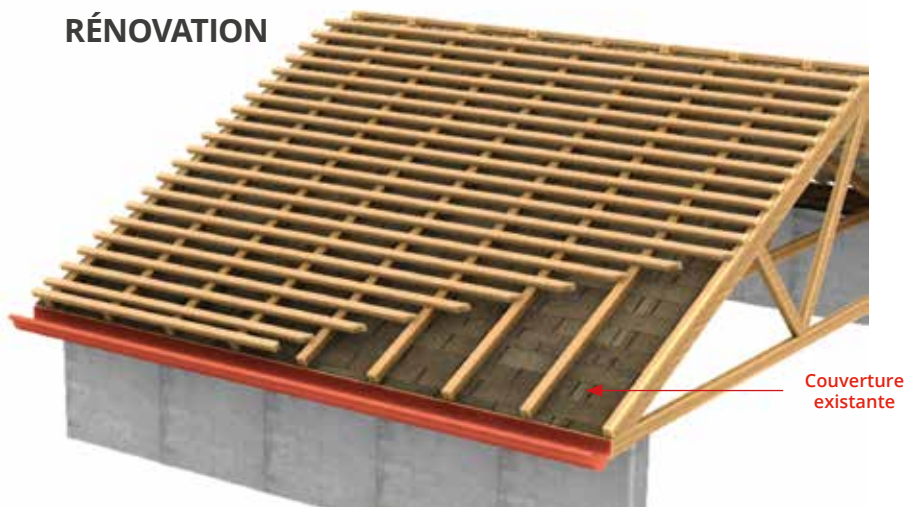

Dimensions(\*)  
de l'ossature secondaire :

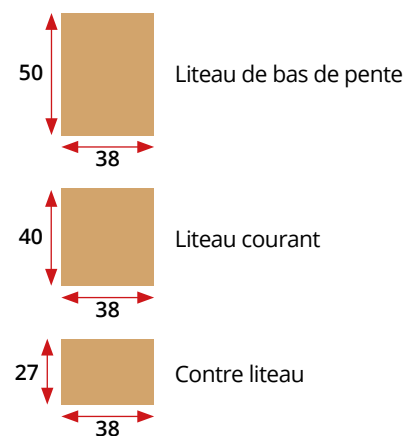

(\*) Dimensions standards couramment vendues par les négociants

## VARIANTES POSSIBLES

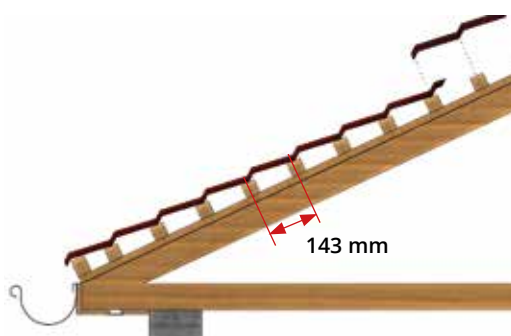

un liteau tous les pureaux



Prévoir un liteau supplémentaire au droit de chaque recouvrement tous les 2 pureaux

un liteau tous les 2 pureaux

## POSE SUR SUPPORT CONTINU



Réalisation du support continu conforme au DTU 40.41

En fonction de la nature du support, un écran d'interposition peut être nécessaire.

## RÉNOVATION



Réalisation du support à l'aide d'une ossature secondaire\* composée de contre-liteaux et de voliges.

La mise en œuvre de l'ossature secondaire en rénovation est identique à la mise en œuvre, en construction neuve, sur voliges.

Si la toiture existante présente des défauts d'étanchéité, un écran de sous toiture est à mettre en œuvre.

\*Dimensions de l'ossature secondaire.

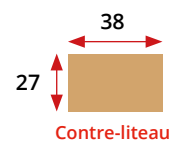
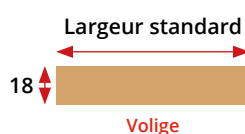



## VENTILATION

En construction neuve ou en rénovation, pour assurer une bonne ventilation de votre toiture une lame d'air de 20mm minimum doit être créée.

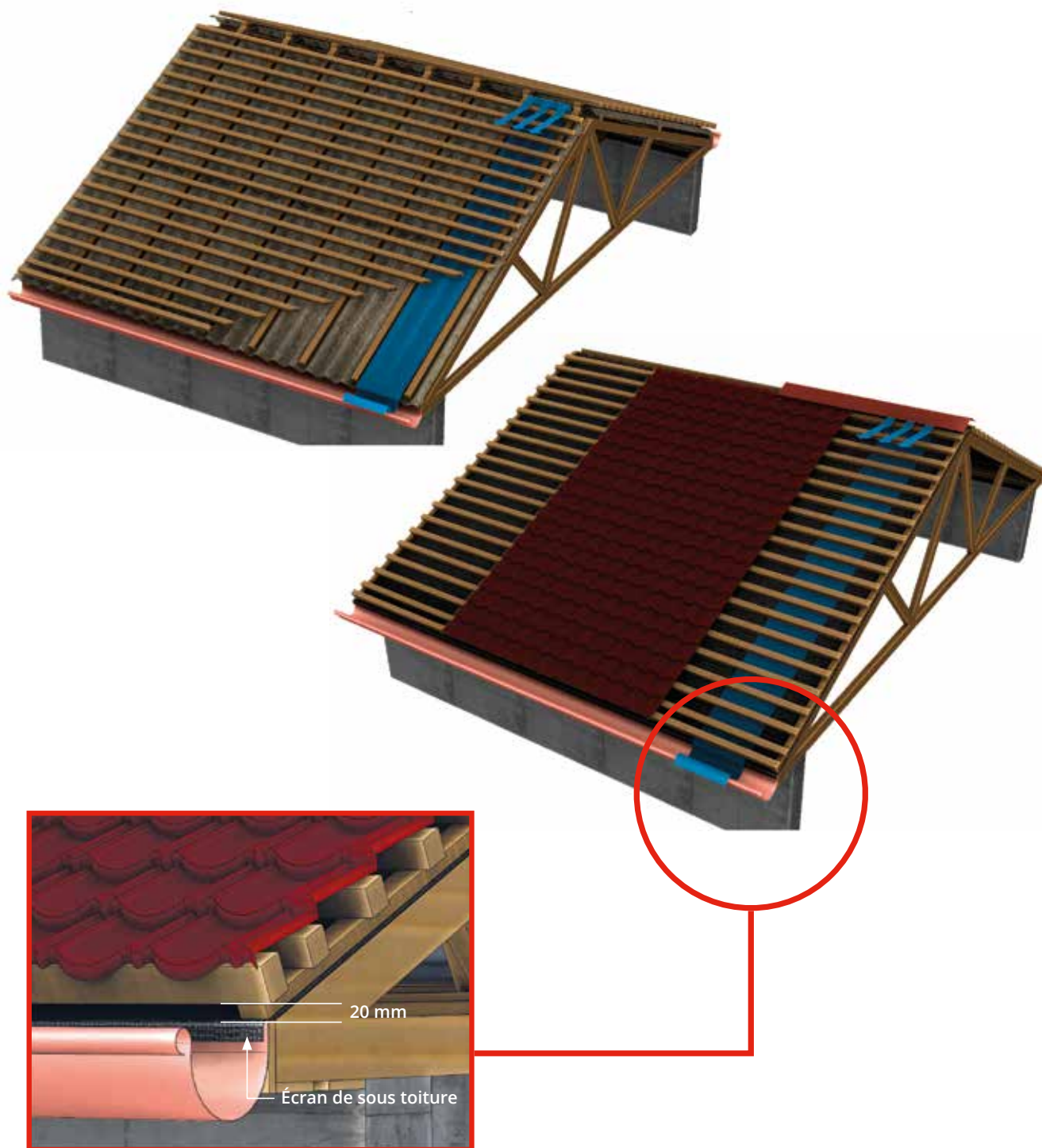

## POSE DE L'ÉGOUT

## ÉTAPE 1



La bande d'égout se positionne en de bas de pente.  
 Pour la maintenir temporairement en position, utiliser deux pointes à clouer aux extrémités.

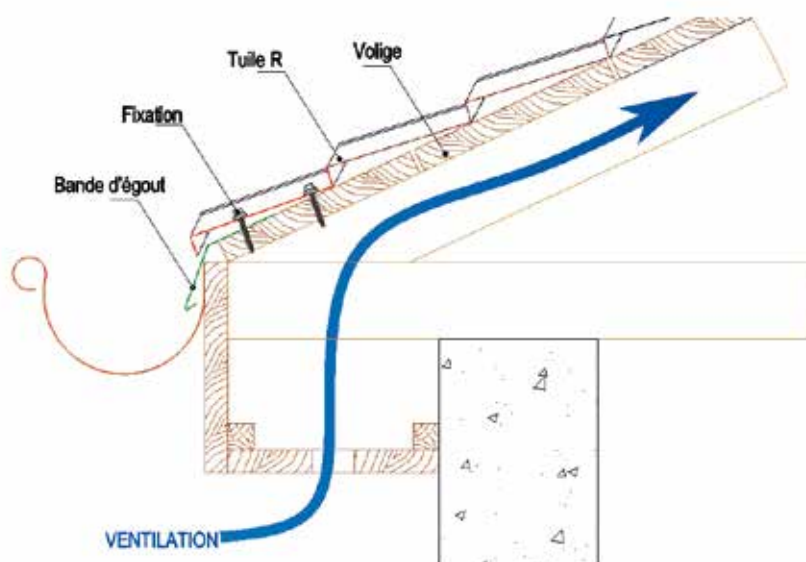

POSE DES RIVES

ÉTAPE 2

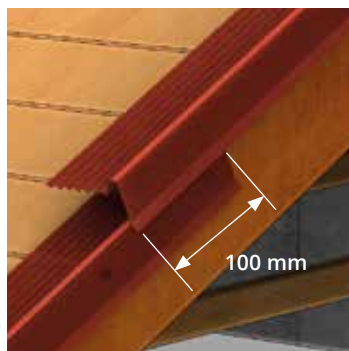
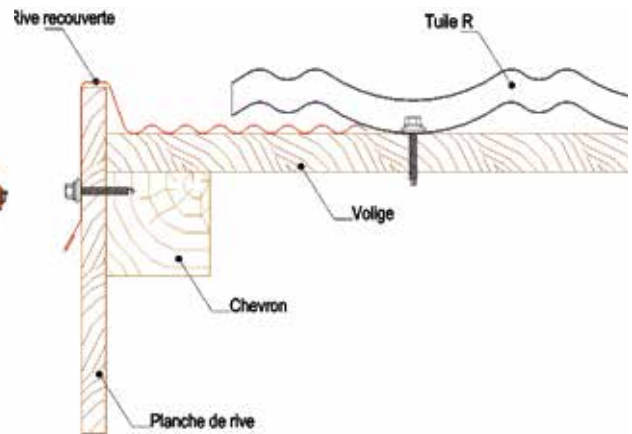

Rive emboîtable sans découpe

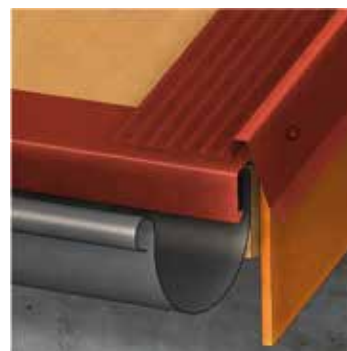

3 fixations par mètre linéaire



Vis de fixation  
Ø4.9x35

FINITION AU FAÎTAGE



D'autres solutions de rive sont possibles, voir page 248.



## POSE DES TUILES R PRO

### ÉTAPE 3

**BON À SAVOIR**

La Tuile R PRO® a la particularité d'être chevauchable, aussi bien sur la longueur que sur la largeur. **Pas besoin de découpe**

#### RECOUVREMENT LONGITUDINAL

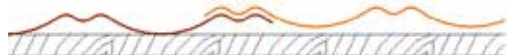

Recouvrement minimal



Recouvrement sur 1 tuile

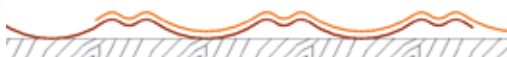

Recouvrement sur 2 tuiles et plus

#### RECOUVREMENT TRANSVERSAL

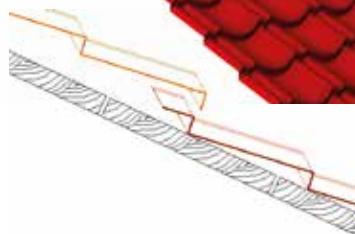
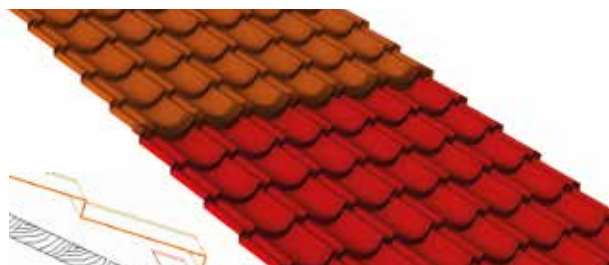

Recouvrement minimal

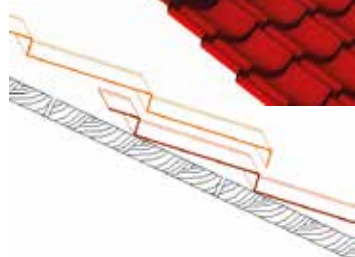
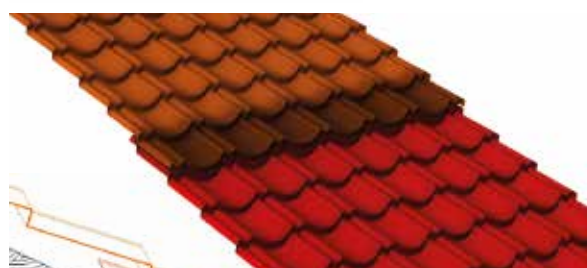

Recouvrement sur 1 tuile

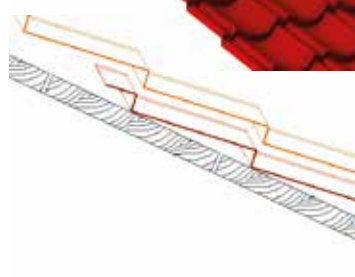
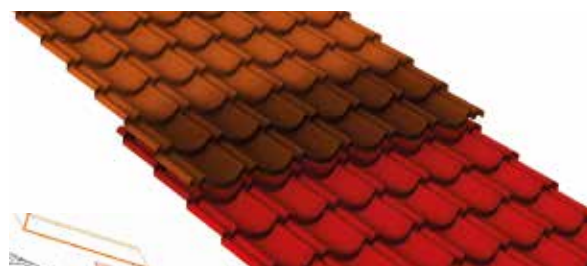

Recouvrement sur 2 tuiles et plus

## POSE DES TUILES R PRO

## PREMIÈRE RANGÉE DE PLAQUE TUILE R

Les plaques Tuile R PRO® se posent toujours en commençant par le bas.

Visser avec 6 vis minimum par plaque .  
La fixation des tuiles se fait toujours en creux d'ondes.

Poser les plaques suivantes en les recouvrant les unes aux autres.

Pour la dernière plaque, adapter le recouvrement longitudinal pour avoir une finition parfaite et sans découpe.

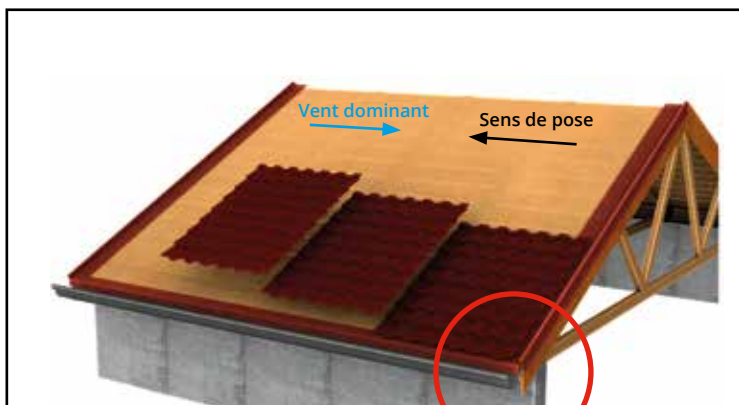

Vis de fixation  
Ø4.9x35



## RANGÉE DE PLAQUES TUILE R PRO® SUIVANTE

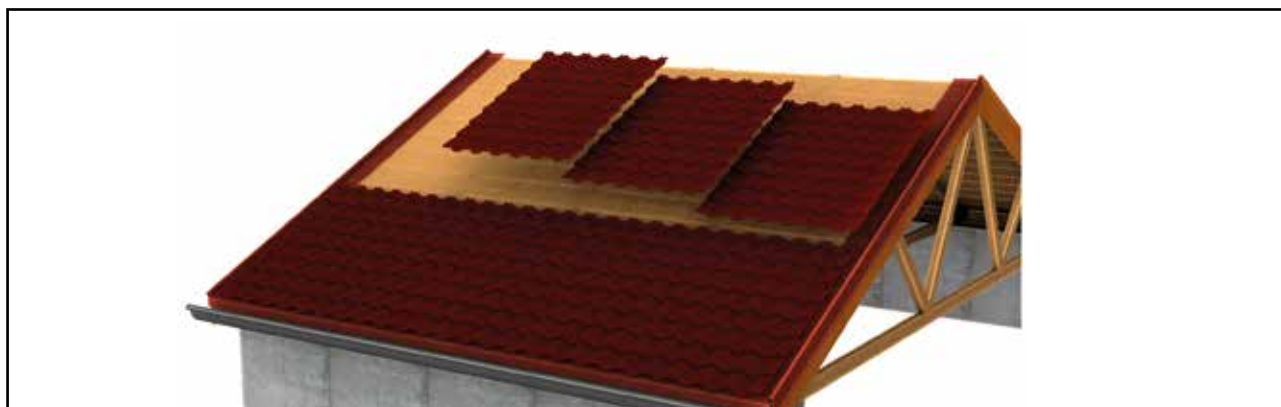



FIXATIONS DES TUILES R PRO

ÉTAPE 4

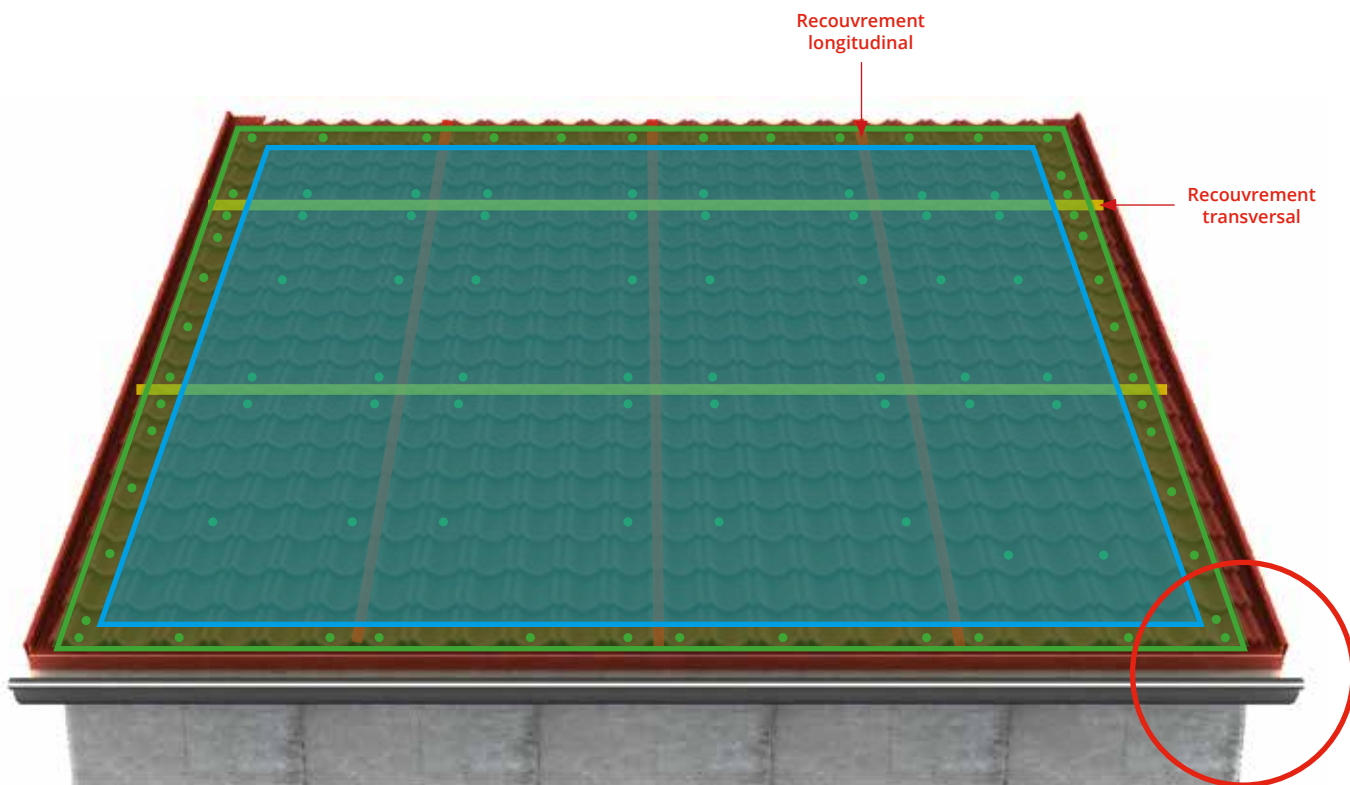

Vis de fixation  
Ø4.9x35

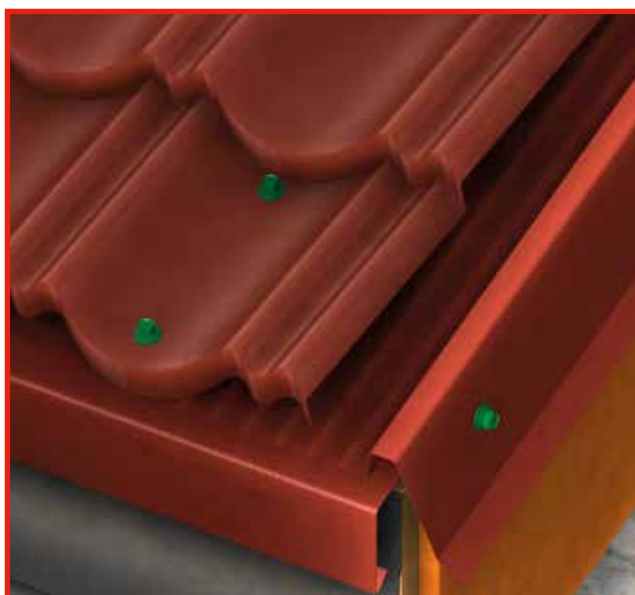

**En rives :** Fixation 1 liteau sur deux  
**Au faitage et à l'égout :** Fixation 1 onde sur deux

**En partie courante :**  
1 Fixation tous les 4 pureaux maximum  
1 Fixation toutes les 4 ondes  
6 fixations / plaques

## POSE DES FAÎTIÈRES

## ÉTAPE 5

Répartissez les faîtières sur toute la longueur de votre toiture

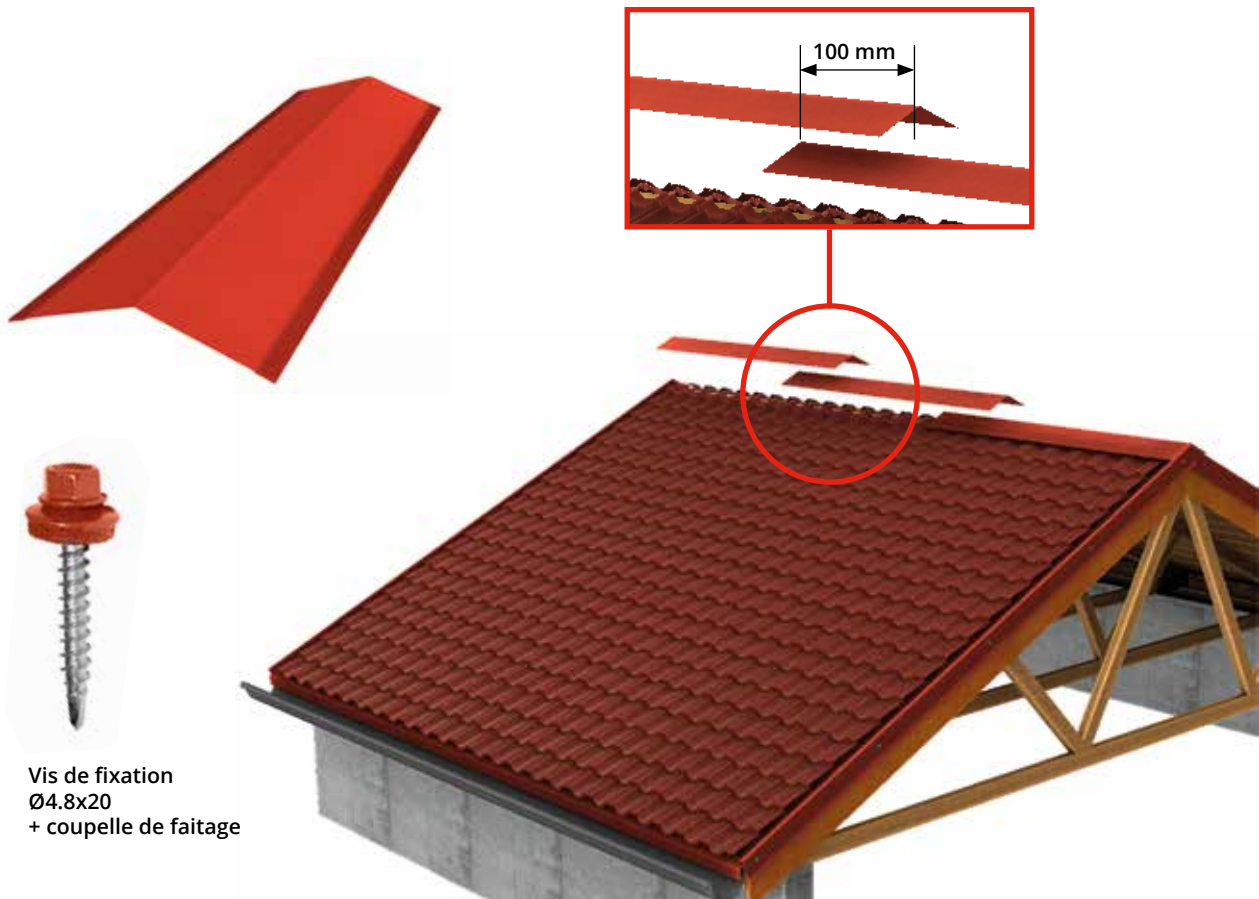

3 fixations par mètre linéaire  
Elles se recouvrent entre elles, inutile de les recouper.

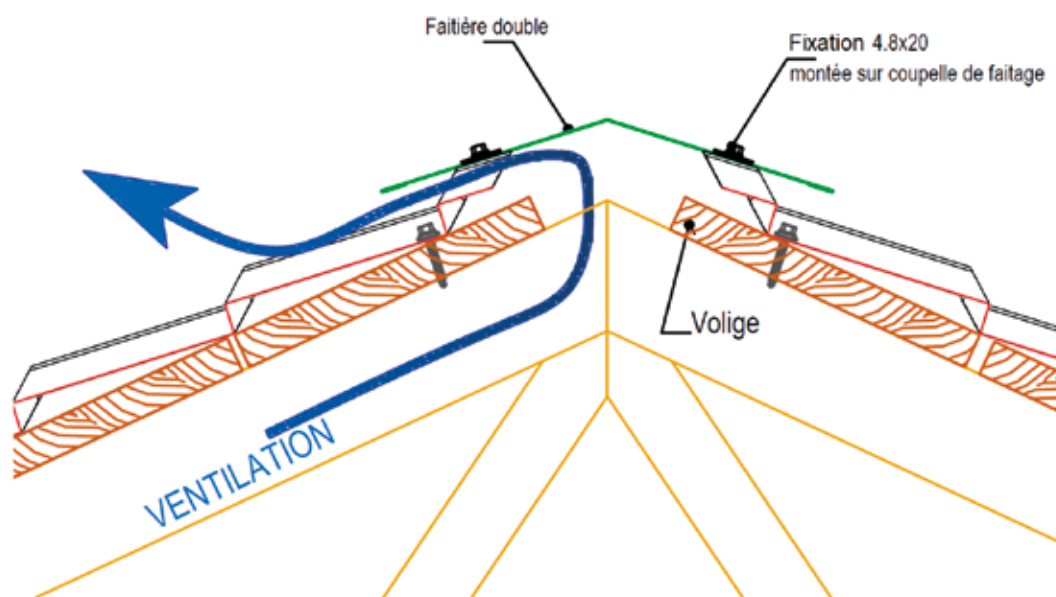

# TRAITEMENT DES POINTS SINGULIERS

## ÉTAPE 6

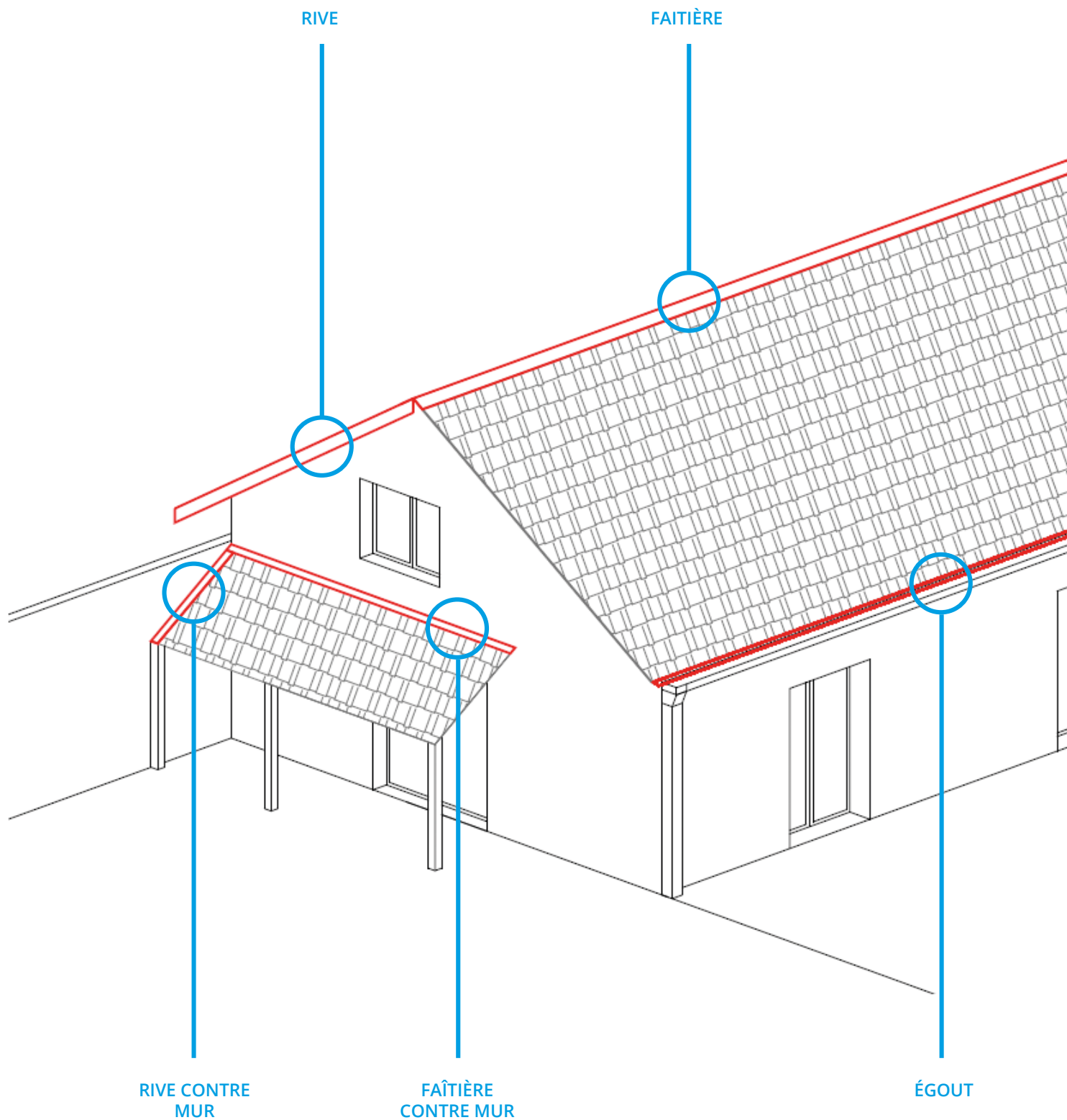



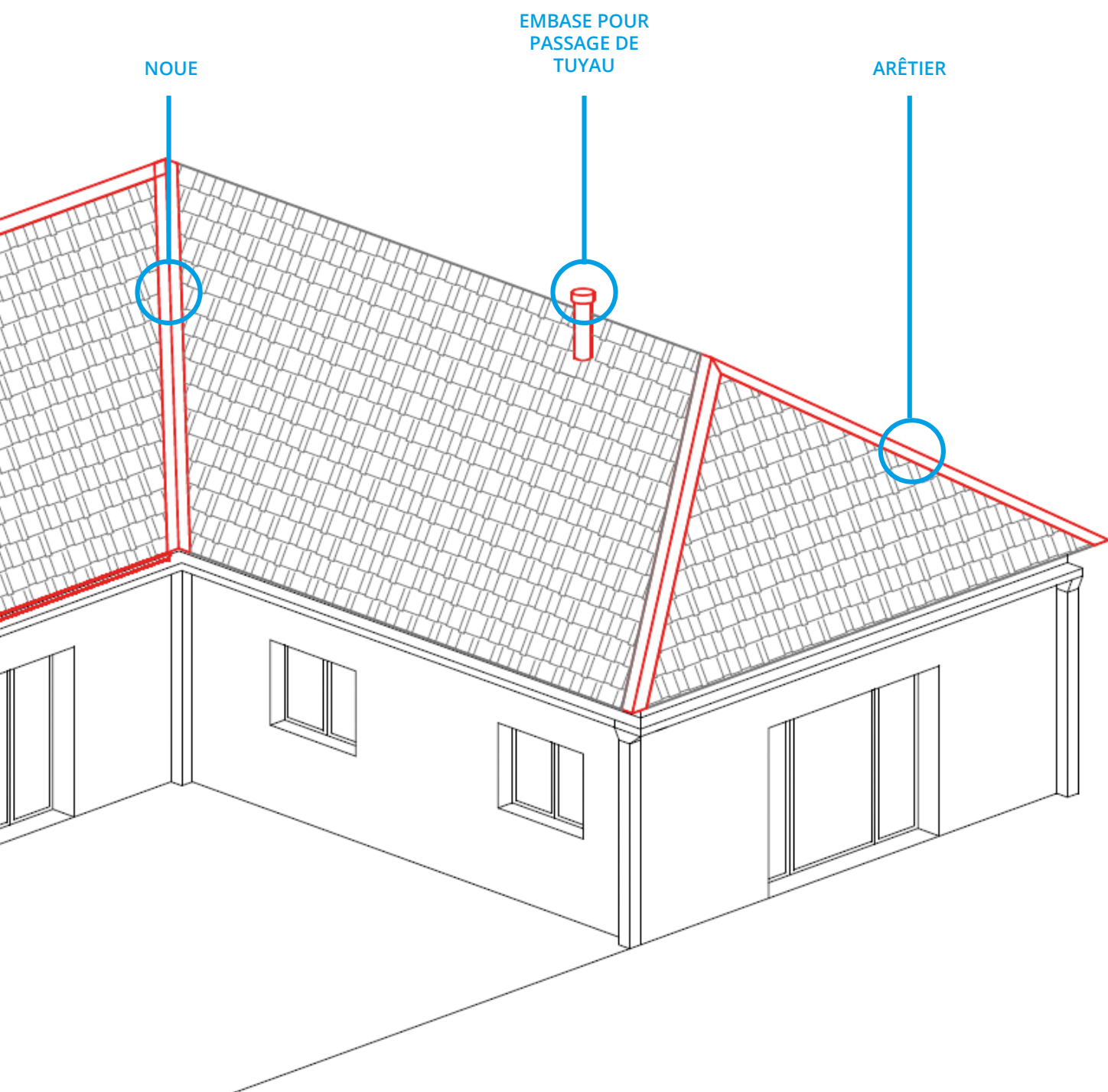

## LES RIVES

### RIVE SIMPLE ONDULÉE

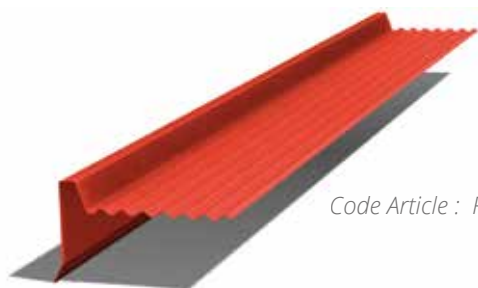
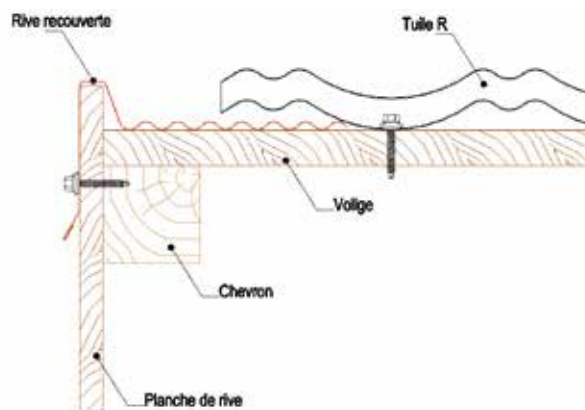

Code Article : RVTUURL50

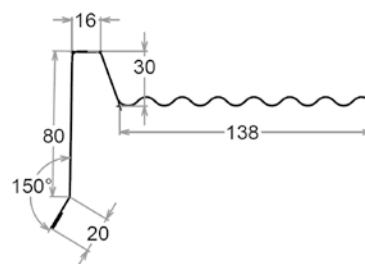

### RIVE COULOIR EN SOLIN

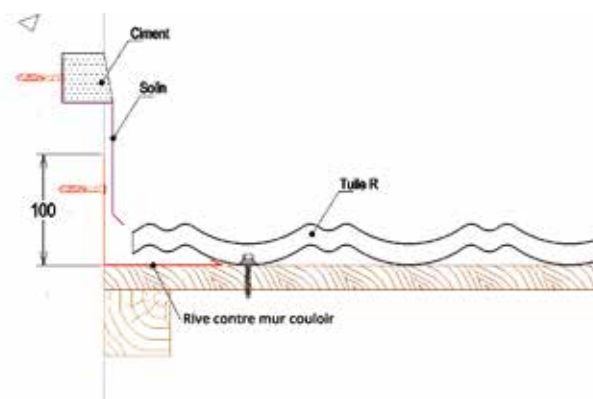

#### RIVE CONTRE MUR COULOIR

Code Article : PLIRCMCTR

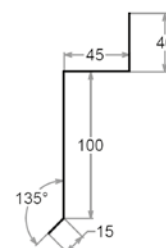
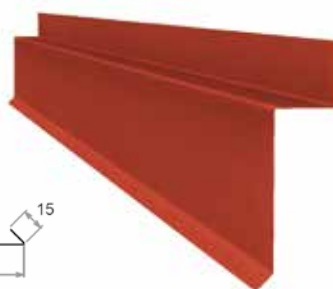

#### SOLIN

Code Article : PLISOLINTR

LES RIVES

RIVE SIMPLE RECOUVRANTE

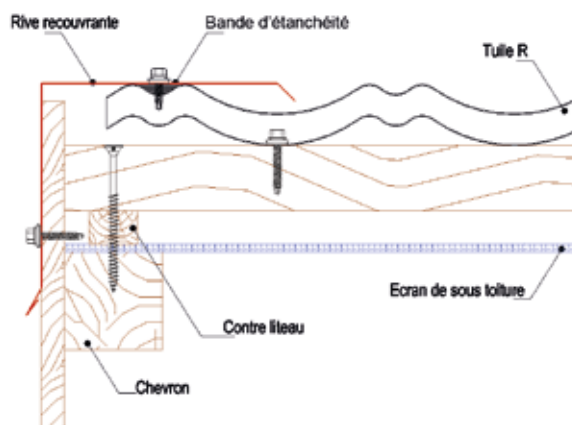

Code Article : PLIRSCTR

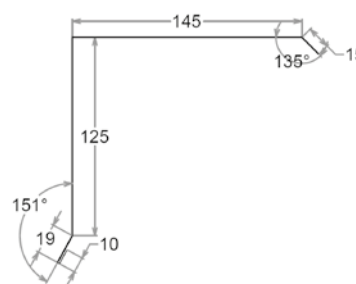

RIVE EN SOLIN

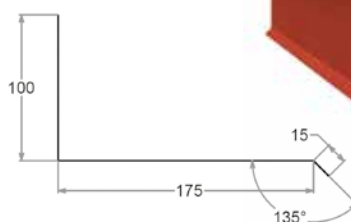
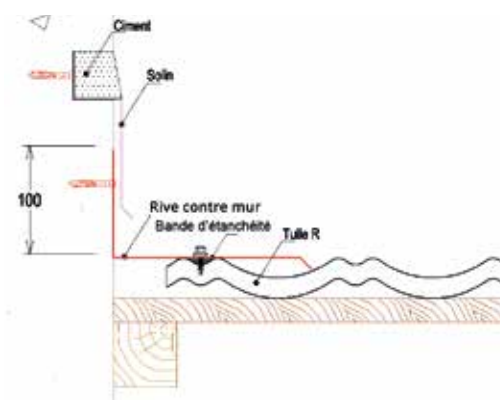

RIVE CONTRE MUR

Code Article : PLIRCMTR

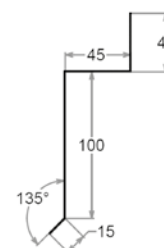
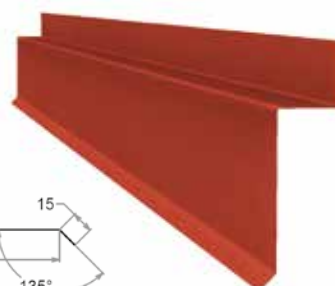

SOLIN

Code Article : PLISOLINTR



LES FAÎTIÈRES

FAÎTIÈRE DOUBLE

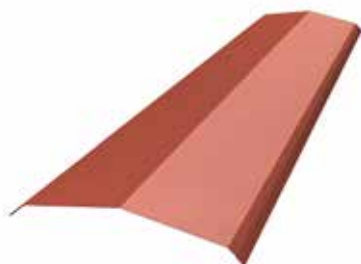
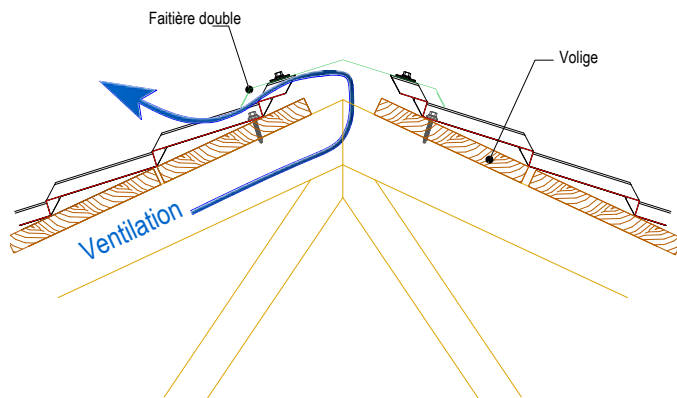

Code Article : FAITUIRL50

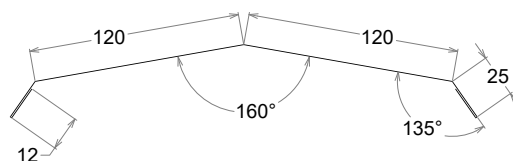

FAÎTIÈRE DOUBLE AVEC REHAUSSE

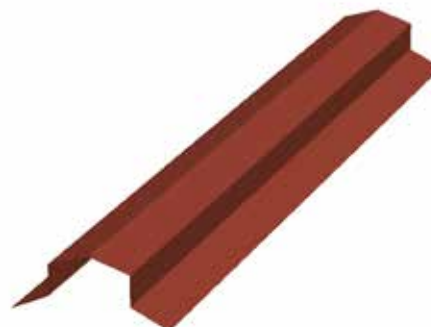
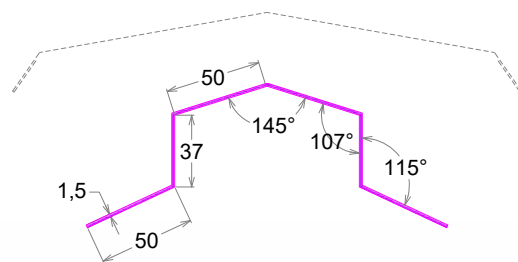
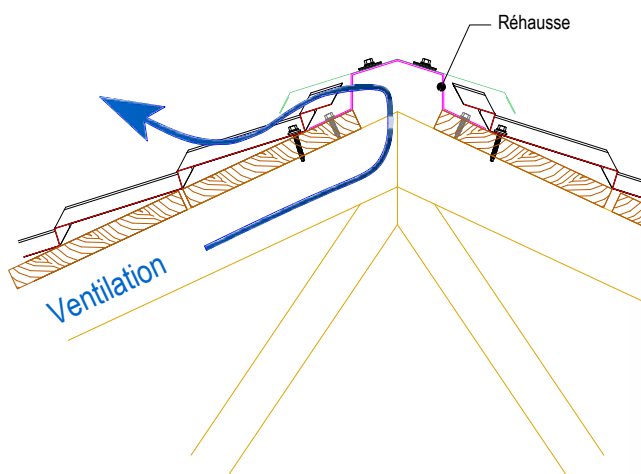

Code Article : PLIREHAUSSEURTR

LES FAÎTIÈRES

FAÎTIÈRE SIMPLE

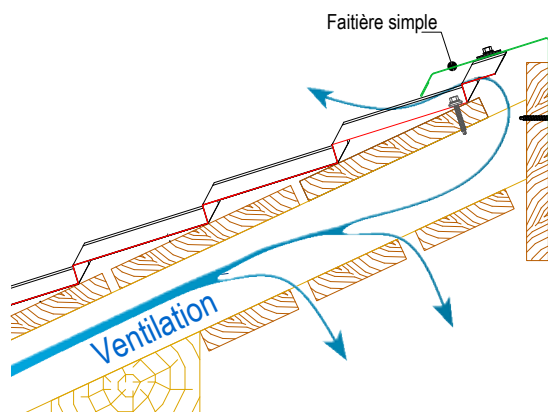

Code Article : PLIFSTR

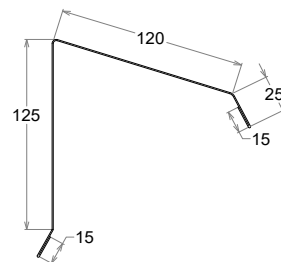

FAÎTIÈRE EN SOLIN

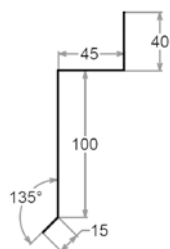
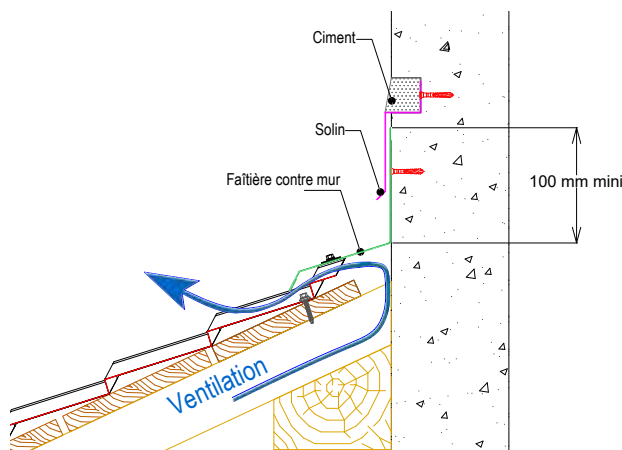
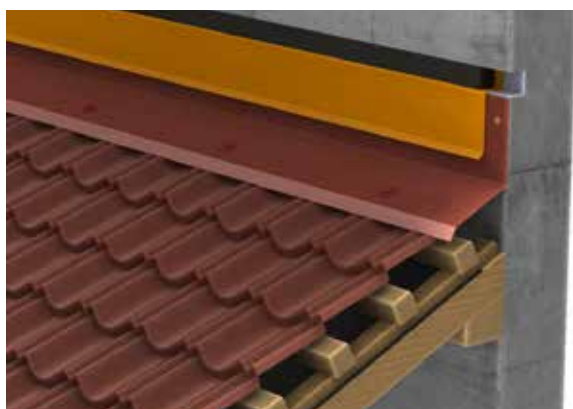

SOLIN

Code Article : PLISOLINTR

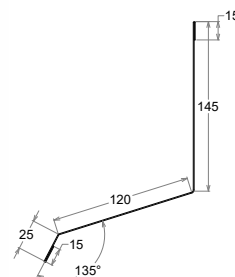

FAÎTIÈRE CONTRE MUR

Code Article : PLIFCMTR

## LA NOUE

- Fixations

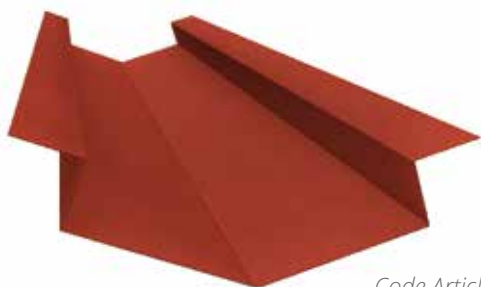
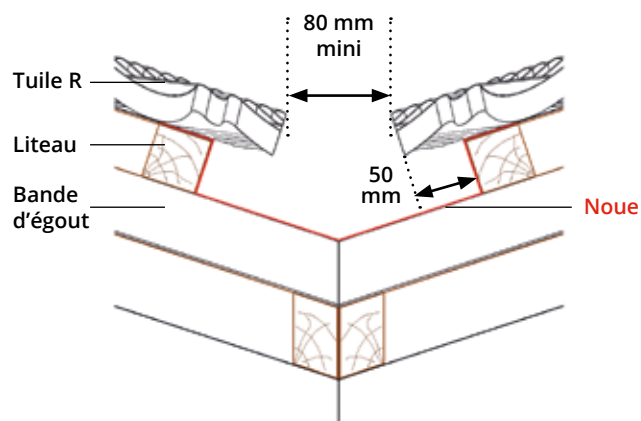
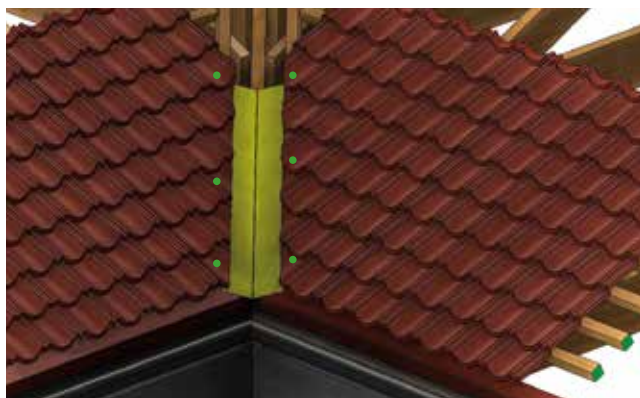

Code Article : PLINOUETR

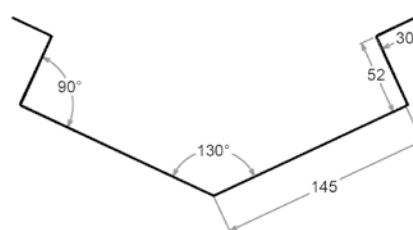

## L'ARÊTIER

- Fixations

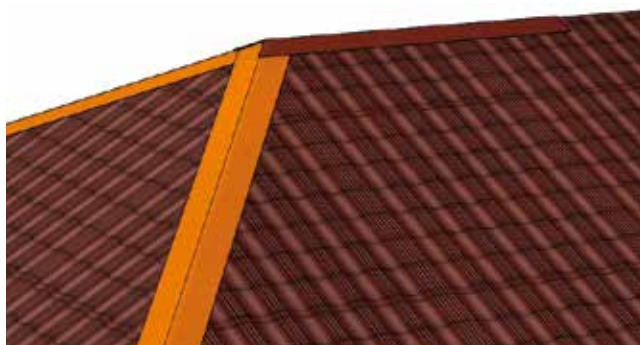
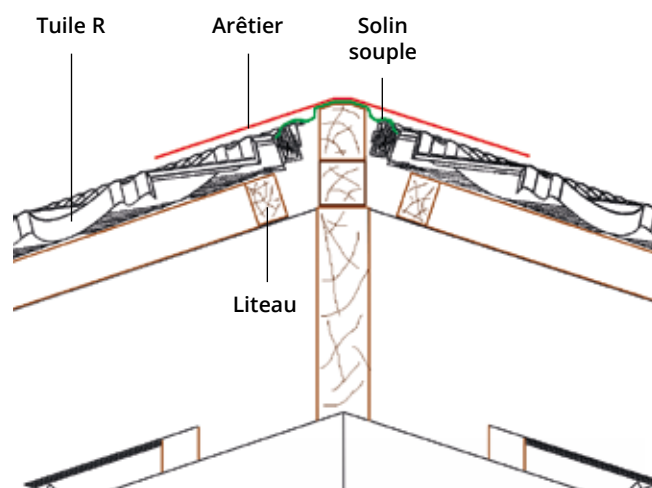
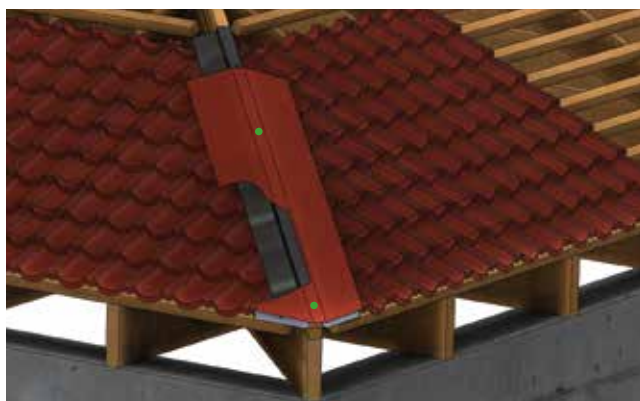

Réalisation de la liaison au faitage



Solin souple

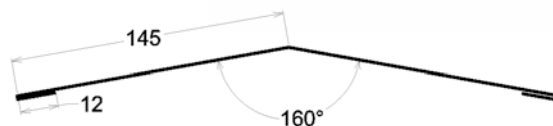

Code Article : PLIARETIERTR



## BANDE D'ÉGOUT

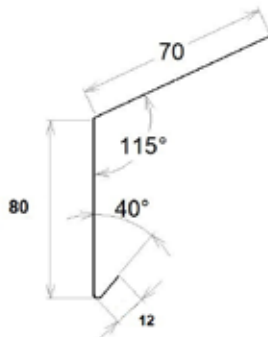

Code Article : BANDEGOUTUIR

## LES SORTIES DE TOITURE

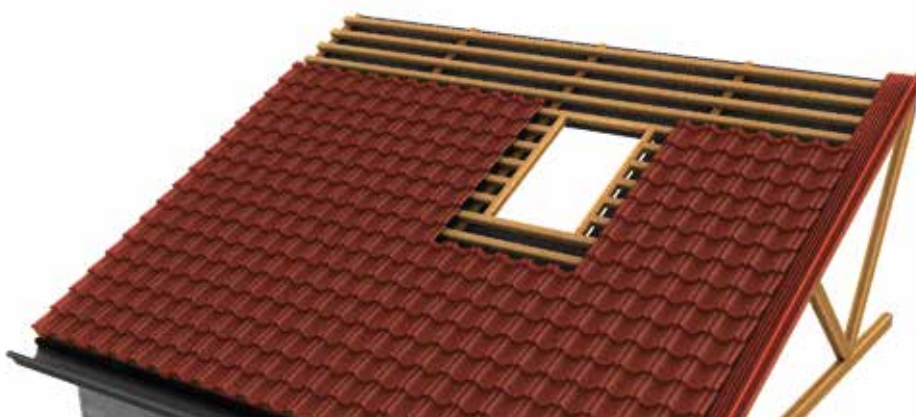

La mise en place d'un chevêtre est obligatoire pour la pose de sorties de toiture.

Les plaques d'adaptation se posent en même temps que les tôles.

Grande adaptabilité, réalisation sur mesure

**i** Elles sont proposées dans les coloris standards polyester.

## PLAQUE POUR PASSAGE DE TUYAU

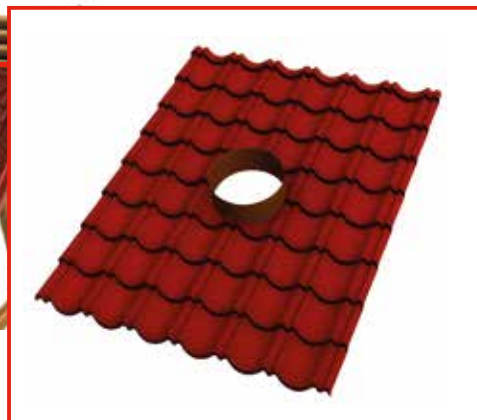
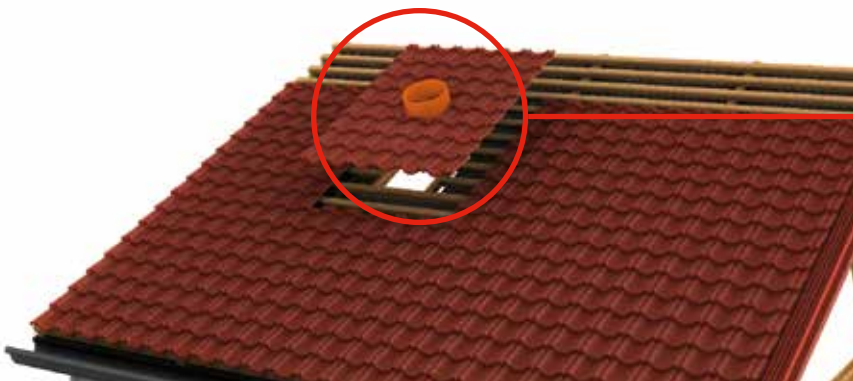

**i** Elles sont proposées dans les coloris standards polyester.

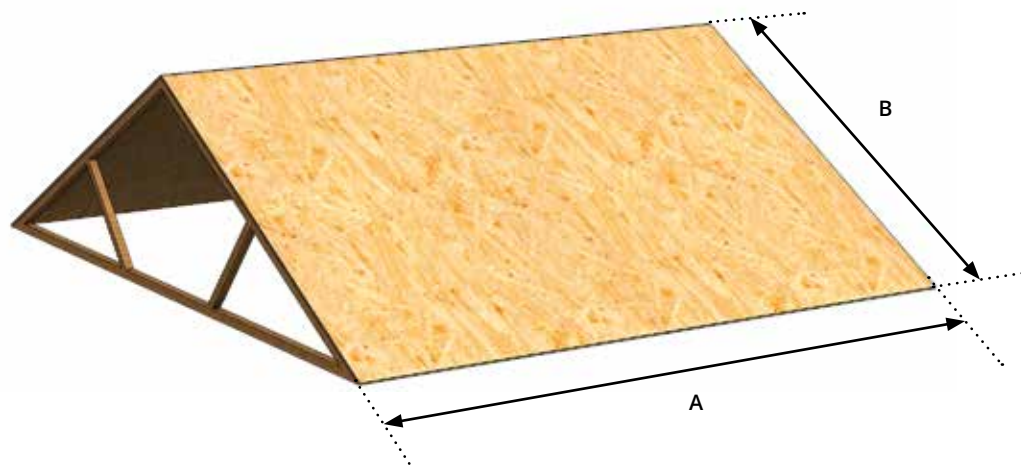

## NOMBRE DE TUILE

EN LARGEUR :  $T_{\text{larg}} = \frac{A}{0,87}$  Arrondir à l'entier supérieur

EN LONGUEUR :  $T_{\text{long}} = \frac{B}{1,1}$  Arrondir à l'entier supérieur

$$\text{TOTAL TUILES} = T_{\text{LONG}} \times T_{\text{LARG}}$$

## NOMBRE DE RIVE

$$N_{\text{rives}} = \frac{B}{1,1} \text{ Arrondir à l'entier supérieur}$$

$$\text{TOTAL RIVES} = N_{\text{rives}} \times 2$$

## NOMBRE DE FAITIÈRE

$$N_{\text{fait}} = \frac{A}{0,9} \text{ Arrondir à l'entier supérieur}$$

$$\text{TOTAL FAÎTIÈRES} = N_{\text{fait}}$$

## NOMBRE DE FIXATIONS

6 FIXATIONS PAR TUILE

3 FIXATIONS PAR RIVE

3 FIXATIONS PAR FAÎTIÈRE

TOTAL TUILES × 6

+ TOTAL RIVES × 3

+ TOTAL FAÎTIÈRES × 3

---

TOTAL FIXATIONS





# BACACIER®

VOUS ÉCOUTE

## BACACIER NORD FLANDRES

152, ROUTE DE BERCK  
62180 RANG DU FLIERS  
**T. 03 21 89 18 18**  
F. 03 21 84 51 62

## BACACIER ATLANTIQUE

ZA VAL DE BOCQ  
86340 LES ROCHES PRÉMARIE  
**T. 05 49 42 50 80**  
F. 05 49 42 06 37

## BACACIER GASCOGNE

10, RUE DE LA MENOUE  
32400 RISCLE  
**T. 05 62 69 90 06**  
F. 05 62 69 90 07

## BACACIER MERIDIONAL

ZA FANJOUGE - ROUTE DE VIVIERS  
07700 BOURG-SAINT-ANDÉOL  
**T. 04 75 54 81 81**  
F. 04 75 54 30 14

## BACACIER AUVERGNE

ROUTE DE CHAPTUZAT  
63260 AIGUEPERSE  
**T. 04 73 64 59 59**  
F. 04 73 64 59 50

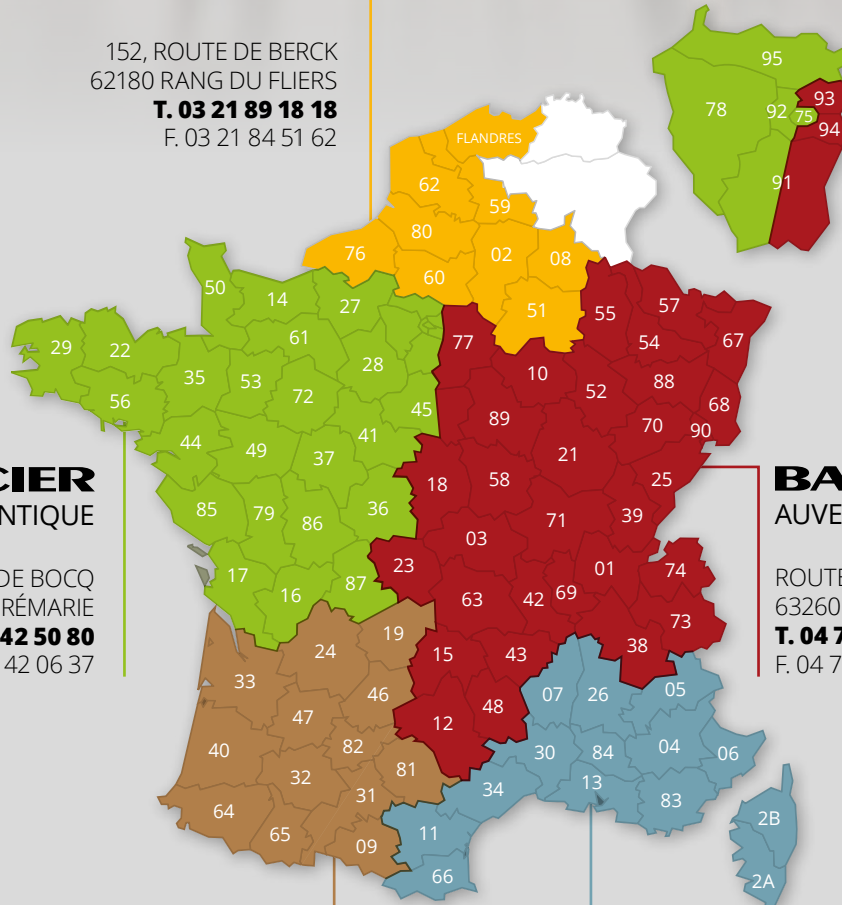

[www.bacacier.com](http://www.bacacier.com)

*Découvrez nos produits et  
tous nos services en ligne*



[open@bacacier.com](mailto:open@bacacier.com)

*Engagement de réponse  
sous 48 heures*



**01 84 16 67 17**

*Du lundi au vendredi de  
8h à 12h et de 14h à 18h*